

## Precision Voltage Measurement Instruments

VOLTpoint™ is a family of precision instruments designed for measuring a wide range of voltage inputs; ideally suited for cell-by-cell battery testing where sources range from millivolts to  $\pm 400V$ . Available in both USB and Ethernet (LXI) versions, VOLTpoint can be configured with up to 48 input channels. Each VOLTpoint instrument ships with a ready-to-measure application, allowing you to view, graph, and export your data.

VOLTpoint uses **ISO-Channel™** technology to eliminate connection problems by using galvanic isolation methods to guarantee 1000V isolation between sensor grounds. The result is that accuracy is preserved for all sensor inputs. Formerly, connections to sensors for industrial measurement have frequently resulted in noisy results or ground loops. The implied assumption is that each sensor's ground is at the same reference potential. But if the grounds are different from one another, severe common mode noise problems occur.

### Applications

- Hybrid-Electric Vehicle (HEV) battery performance
- Li-ion Cell measurements
- High voltage, precision battery stack, or cell balance measurements
- High power portable equipment
- Motor shunt measurements
- Commercial, military hybrid vehicles
- Fuel cell stacks
- High voltage data acquisition
- Battery back-up monitoring

### Key Design Features

- **ISO-Channel™** for each input signal... preserves accuracy
- **Dedicated 24-bit, Delta Sigma A/D converter** for each voltage input channel for simultaneous, high-resolution measurements
- **1000V galvanic isolation** channel-to-channel and to the host computer to protect signal integrity
- **Maximum 300 $\mu V$  error** for  $\pm 10V$  range, 2mV error for  $\pm 100V$  range
- **3 software selectable input ranges** on voltage boards:  $\pm 10V$ ,  $\pm 100V$ ,  $\pm 400V$  on a per channel basis
- Easy access jacks for **quick wiring**
- **Ethernet or USB** operation



Figure 1. VOLTpoint allows direct battery cell connection of voltages up to  $\pm 400V$  with 1000V isolation between any of the 48 channels. Ground loops are eliminated through the isolation of each channel using the ISO-Channel technology. The  $\pm 10V$  range allows resolution and accuracy of less than 300 microvolts. The  $\pm 400V$  range is available for measuring stacked cells or higher voltages.

### Voltage Inputs

VOLTpoint instruments support up to 48 inputs with 24-bit resolution per channel. The DT9873 and DT8873 provide 3 software selectable input ranges on voltage boards:  $\pm 10V$ ,  $\pm 100V$ ,  $\pm 400V$  on a per channel basis. The VOLTpoint architecture uses an A/D per channel, allowing sampling rates of up to 10Hz per channel over all 48 channels.

### High-Stability, Low Drift Voltage References

VOLTpoint uses high-precision, high-stability, low-drift voltage references rated at 4 PPM per degree and 100 PPM drift per year. This means VOLTpoint is accurate now and will remain that way over time.

### Digital Input/Output Lines

VOLTpoint instruments feature eight, isolated, digital input lines. The digital input lines operate from +3 to +28V DC, with a switching time of 2ms maximum. VOLTpoint instruments are perfect for driving relays directly, featuring eight, isolated, digital output lines. The outputs are solid-state relays that operate at  $\pm 30V$  and 400mA peak (AC or DC) with a switching time of 2ms maximum. VOLTpoint instruments include channel-to-channel isolation of up to 250V between digital I/O lines. If the application requires greater channel-to-channel isolation, every other digital line may be used. This reduces the number of digital I/O lines, but provides channel-to-channel isolation of 500V (one channel can be +250V while the adjacent channel can be -250V).

## ISO-Channel™

ISO-Channel uses galvanic isolation methods to guarantee 1000V isolation between any input channel to any other input channel and earth ground. Common mode noise and ground loop problems are eliminated with ISO-Channel since sensors that are at different ground reference levels are easily accommodated, even if they are at widely differing voltages of hundreds of volts or transients to thousands of volts.

ISO-Channel vastly increases reliability by implementing a 24-bit A/D converter per channel on each of many channels, all operating in parallel. Older system designs with relay front ends are prone to system failure through “sticking channels” or magnetic field influence. The all solid-state ISO-Channel provides digital transfer of valuable sensor data with optical or transformer isolation.

The result is that accuracy is preserved for all sensor inputs. This is especially useful when conditions change in the electrical environmental due to motor current surges, electromagnetic radiation, or noisy industrial equipment turning on/off.

## Remote Measurements

The network-ready versions of VOLTpoint (DT8873) provide a standard Ethernet connection to support remote monitoring and control from the field or on the factory floor. Input channels can be expanded by simply adding more instruments to the network.

## Custom Designed DC-DC Converters

Our custom DC-DC converters circuits have a unique power distribution system that supplies power to only 2 of the 6 boards at any one time. Cycling non-adjacent boards in this manner creates less power surges, reduces noise, and improves the overall system performance.

## 1000V Galvanic Isolation

A vast majority of applications reside in industrial environments. By their nature, such environments create a wide variety of problems for data acquisition systems. Noise and high voltage inherent in industrial machinery can adversely affect a measurement instrument, from a relatively benign discrepancy in an acquired value to the destruction of the entire instrument. High quality galvanic isolation helps both situations. Galvanic isolation improves system accuracy by eliminating the unwanted effects of voltage transients, ground loops, and acts as an “insurance policy” against the damaging effects of high voltages. Plus running at 10Hz provides extremely high normal mode rejection for power line related noise. The combination of isolation, Sigma-Delta inherent filtering, and the added analog filtering to remove high-frequency noise, gives the ultimate in measurement performance.

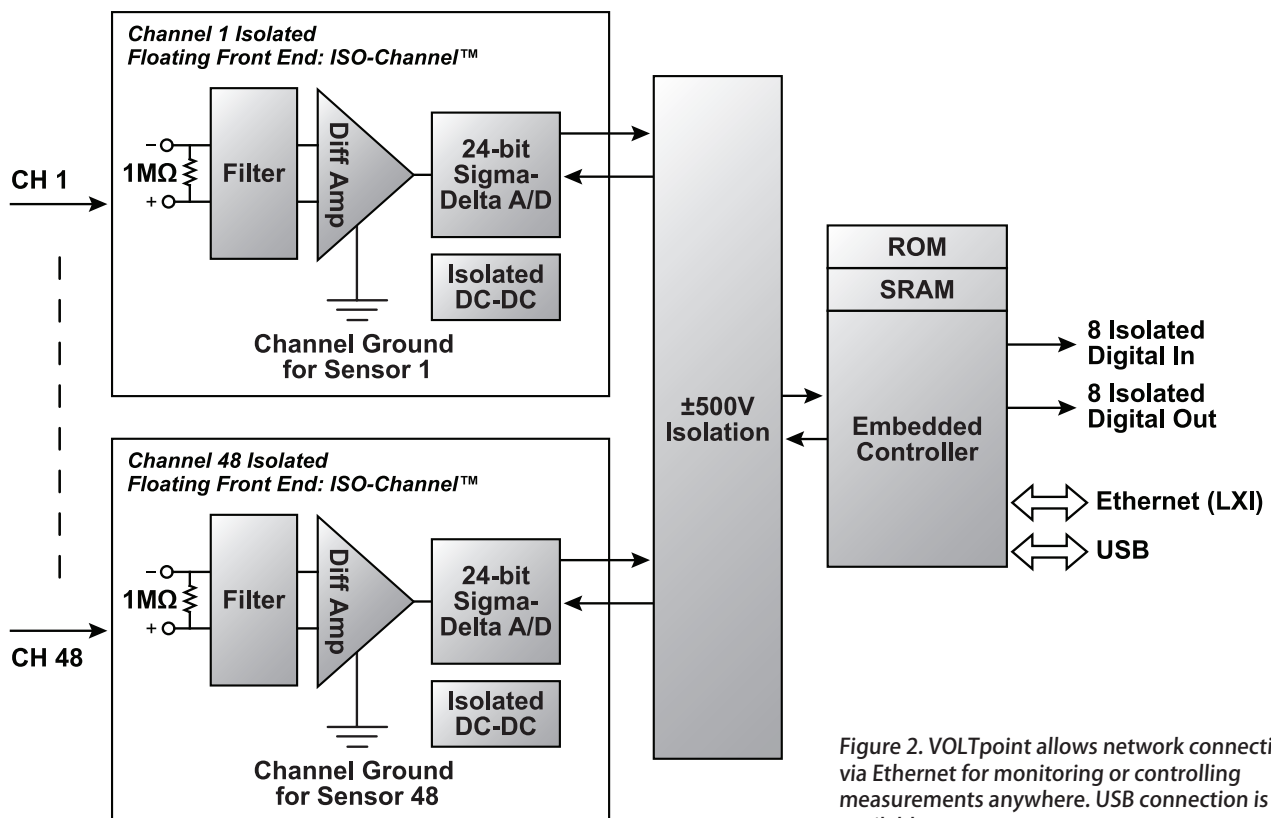

Figure 2. VOLTpoint allows network connection via Ethernet for monitoring or controlling measurements anywhere. USB connection is also available.

# Physical Features

## Front Panel

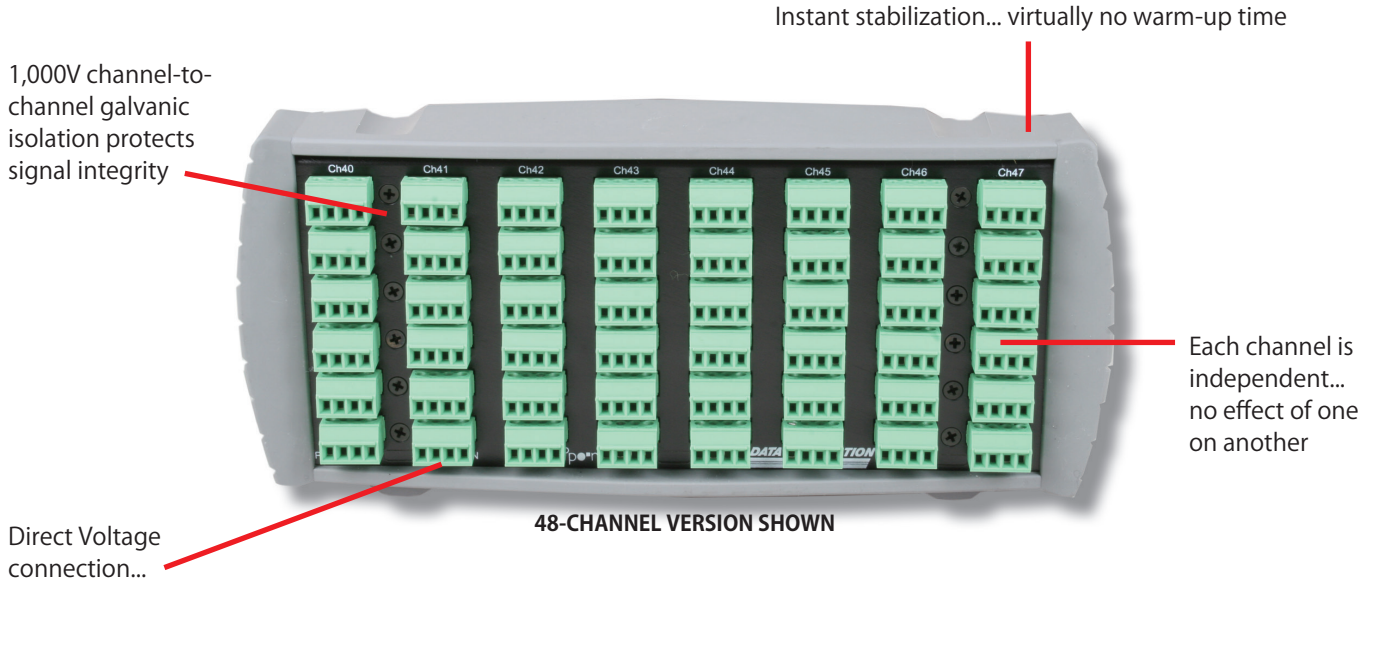

Figure 3. Every channel provides direct precision voltage connections as shown above.

## Rear Panel

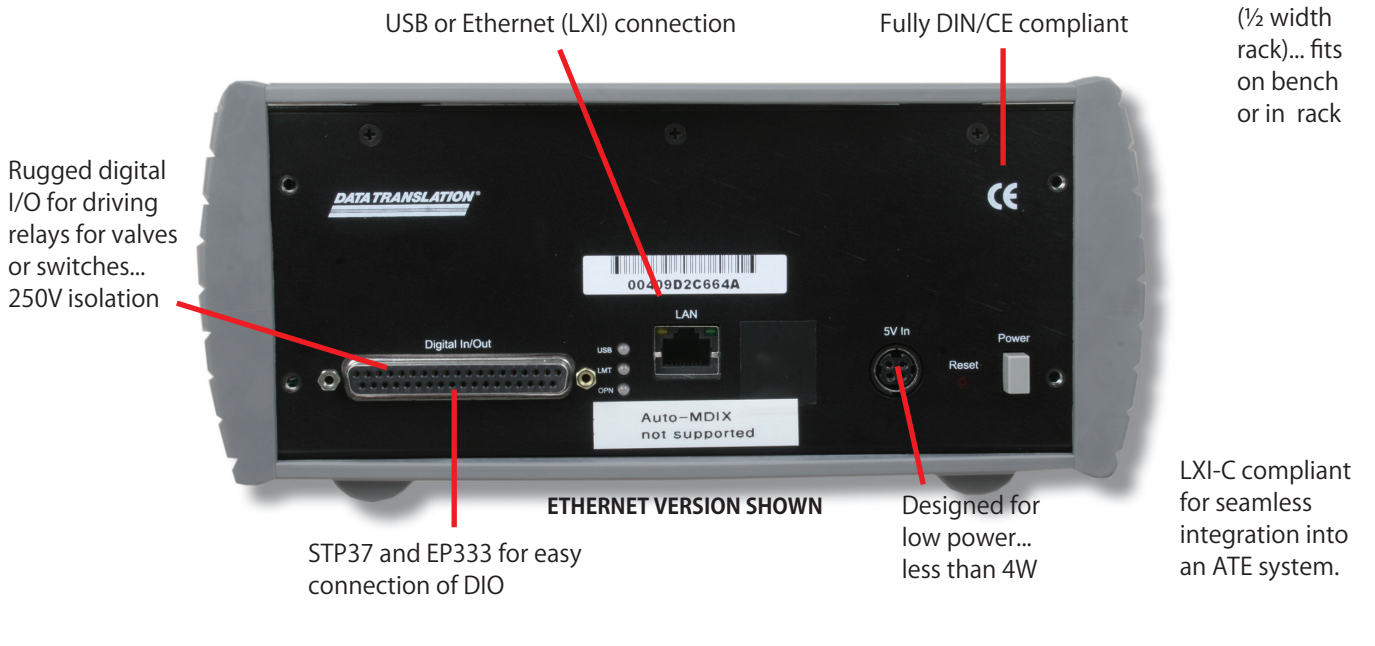
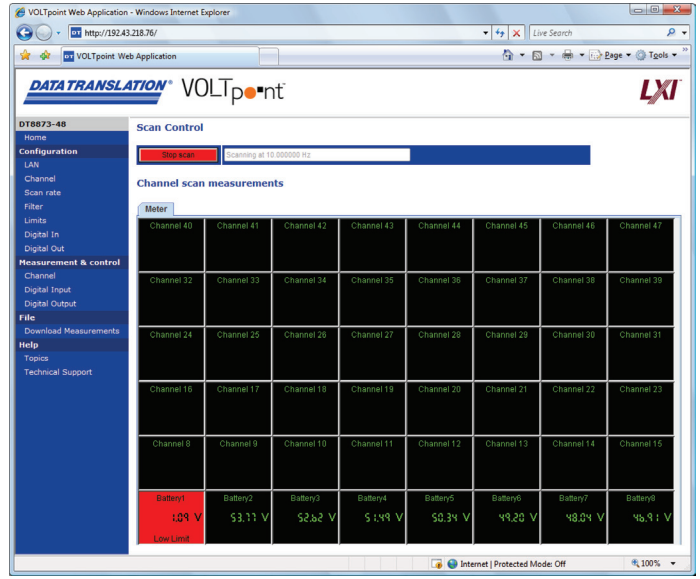
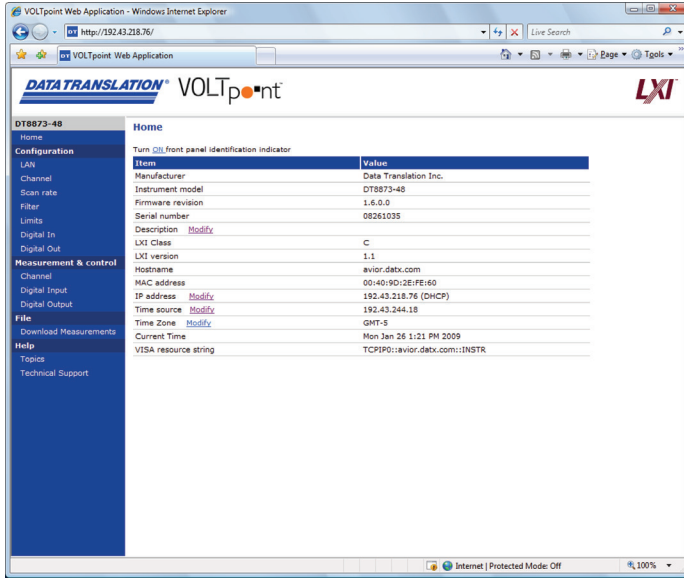

Figure 4. Digital I/O, power, and USB or Ethernet connections are provided on the back panel.

# Web-Based Application & Setup



## Web Access

Using the built-in web-based application, you can configure, measure, and control the VOLTpoint instruments either locally or remotely.

## Measurement & Control Pages

You can use the measurement and control web pages to start or stop a scan, update the value of the digital output port, or read the value of the digital input port.

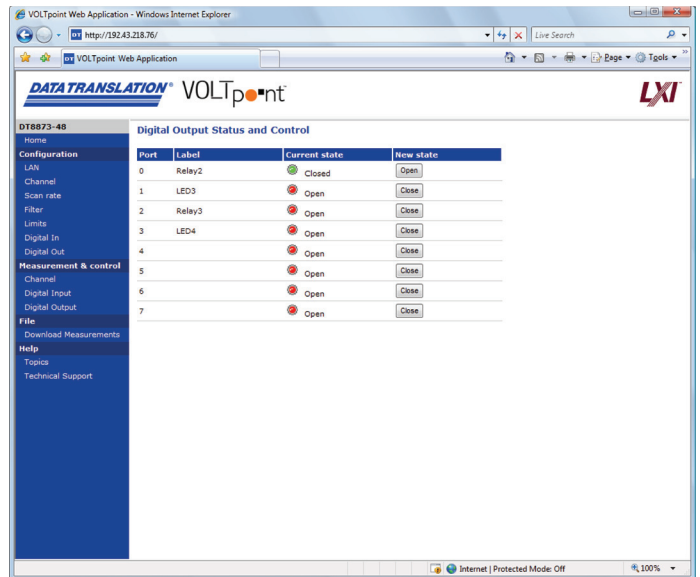
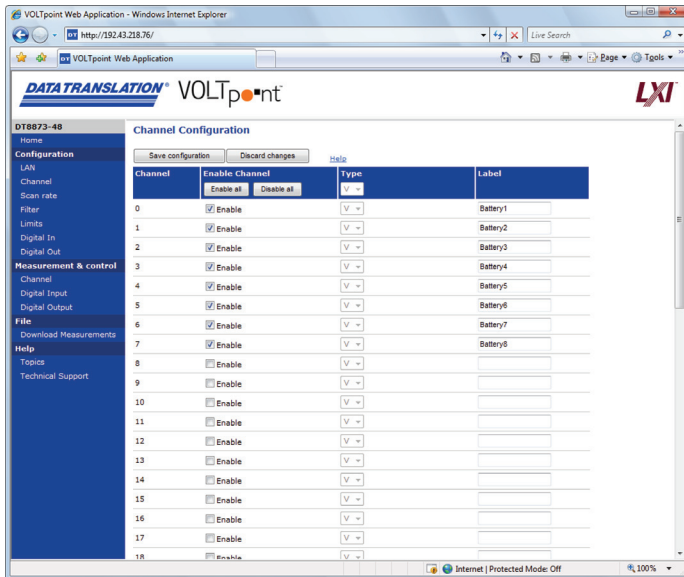

## Configuration Pages

Web pages are provided for configuring the following aspects of your VOLTpoint instrument: Local Area Network (LAN), input channels that you want to measure, scan parameters (such as the scan rate), alarm limits, and digital I/O lines.

## MEASURpoint Framework application

The MEASURpoint Framework application is included with all VOLTpoint instruments. This ready-to-measure application allows you to acquire thermocouple, RTD, and/or voltage data from multiple instruments, record data to disk, display the results in both a plot and a digital display, and read a recorded data file.

### Key Software Features

- Discover and select instruments
- Configure all input channel settings for the attached sensors
- Load/save multiple hardware configurations
- On each device, acquire temperature and voltage data from all enabled channels simultaneously at up to 10Hz per channel
- Log acquired data to disk
- Display acquired data during acquisition in a digital display using the Channel Display window and/or as a waveform in the Channel Plot window
- View statistics about the acquired data, including the minimum, maximum, and mean values and the standard deviation in the Statistics window
- Open recorded data in Microsoft Excel® for further analysis
- Customize many aspects of the acquisition, display, and recording functions, including the acquisition duration, sampling frequency, trigger settings, filter type, and temperature units to use
- Fully configurable graphical user interface

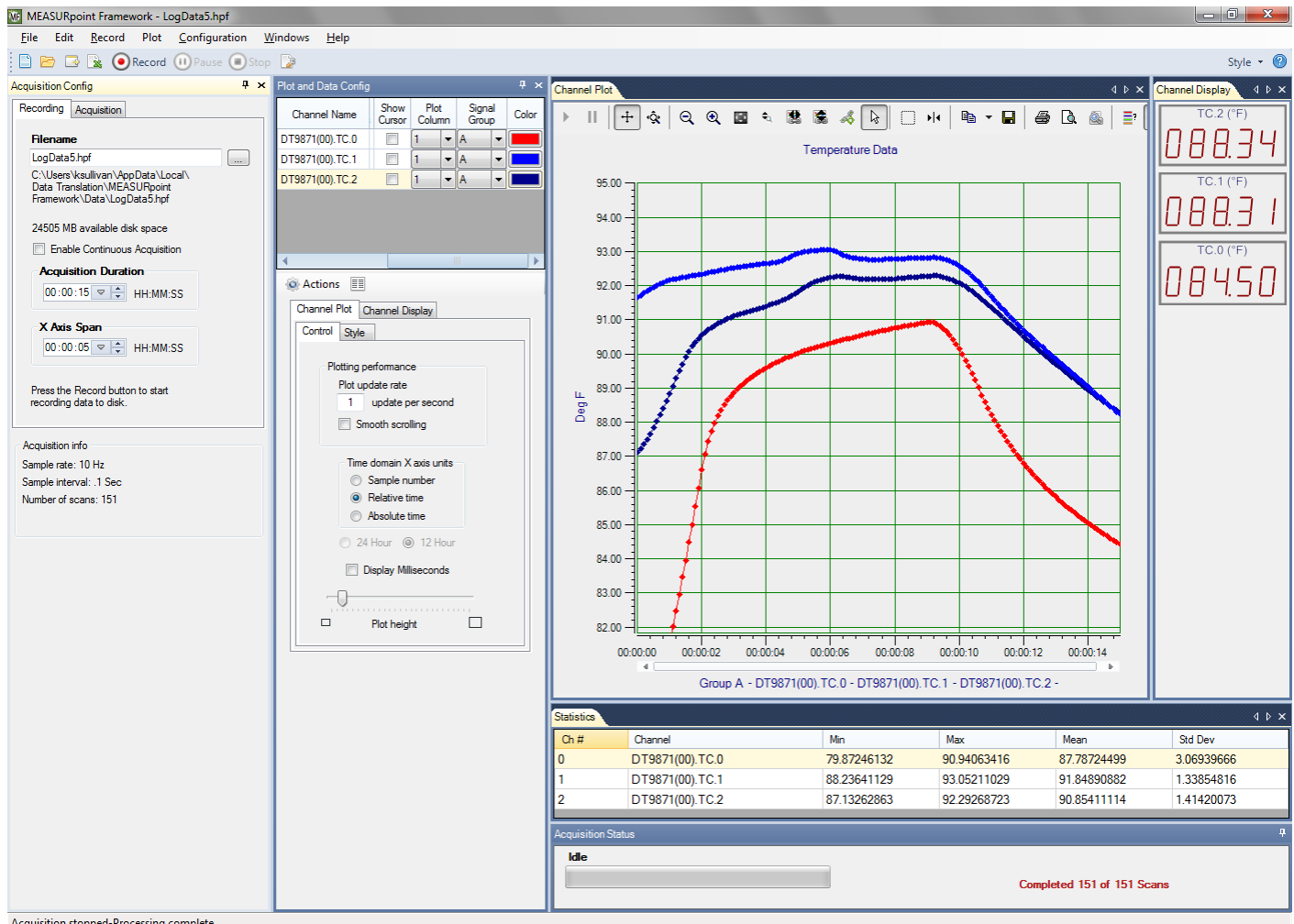

Acquisition stopped-Processing complete

## Additional Software Support

- **Eureka Discovery Utility** – This utility helps you locate or “discover” all LXI (Ethernet) instruments that are connected to your system and provides the following information about your instrument: the IP address, manufacturer, model number, serial number, and version of the firmware that is running on your instrument. In addition, you can use this utility to configure Windows firewall settings and update the firmware for your Data Translation LXI instrument.
- **Instrument Web Interface** – This built-in interface allows you to verify the operation of your instrument and perform basic functions with Internet Explorer and no additional software. Using it, you can configure your instrument, control output signals, measure input signals, and save results to disk.
- **IVI-COM Driver** – This driver is provided to write application programs for VOLTpoint using an IVI-COM instrument interface. It can be used with programs written in Visual C#®, Visual Basic® for .NET, or C++ under Visual Studio® 2005/2008. You can also use the IVI-COM driver with LabVIEW® from National Instruments’ or MATLAB® and the Instrument Control Toolbox from the MathWorks™ to program VOLTpoint instruments.
- **SCPI Commands** – Use VISA or network sockets to program and control VOLTpoint LXI instruments by sending SCPI commands. Comprehensive user manual and example programs provided.

## Ordering Summary

### VOLTpoint Instruments

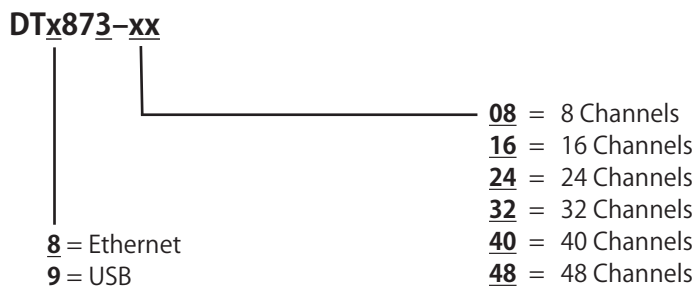

#### Ordering Examples

**DT9873-48**

VOLTpoint USB instrument configured with 48 channels.

**DT8873-08**

VOLTpoint Ethernet instrument configured with 8 channels.

*For additional channel configurations, please call 1-800-525-8528 or email [info@datatranslation.com](mailto:info@datatranslation.com) to discuss your requirements.*

### Options

- **STP37** – Digital I/O screw terminal panel
- **EP333** – Cable for attaching the STP37 to the VOLTpoint instrument
- **EP373** – Single Rack-Mount Kit
- **EP374** – Dual Rack-Mount Kit

For more information about VOLTpoint, please visit:  
<http://www.datatranslation.com/info/VOLTpoint/>

Copyright © 2011 Data Translation, Inc. All rights reserved. All trademarks are the property of their respective holders. Prices, availability, and specifications are subject to change without notice.